

Linear

MOMO-R R030

Fixture Guide

KKDÖ

Indoor/Outdoor | Recessed | Output up to 2309lm/m (704lm/ft)



Key applications

- ✓ Bathrooms
- ✓ Ceiling
- ✓ Direct lighting
- ✓ Downlighting
- ✓ Exterior
- ✓ Interior
- ✓ Wall grazing
- ✓ Wallwashing
- ✓ Wet area

Key features

- ✓ Asymmetric lens
- ✓ Custom lengths
- ✓ Constant Voltage (CV)
- ✓ Diffusion: homogenous
- ✓ Direct view
- ✓ Extensive CCT range
- ✓ Glare control options
- ✓ IP44 moisture resistant
- ✓ IP67 waterproof
- ✓ Lens options

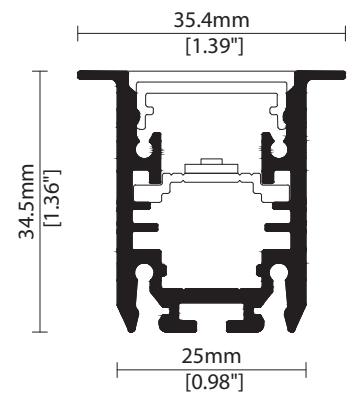

MOUNTING METHODS



KKSB-01 Spring bracket

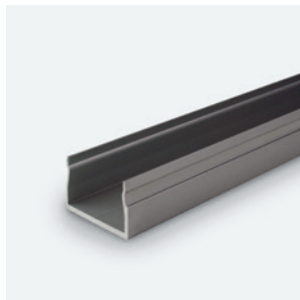

KKCR-01-1000 Cable raceway (1000mm)
KKCR-01-2000 Cable raceway (2000mm)
KKCR-01-3000 Cable raceway (3000mm)

Linear

MOMO-R R030

Specification sheet



| | |
|-----------------------|--|
| Dimensions | H34.5/W35.4/L108-2025mm* (H1.36/W1.39/L4.25-79.72in*) *KKLN-A2 = 1025mm/40.35in max |
| PCB Cut-point | 41.7mm increment/2000mm* max (1.64in increment/78.74in max*) *KKLN-A2 = 1000mm/39.37in max |
| LED Pitch | 6.95mm-144LED/m (0.27in - 44LED/ft) |
| Chip | s-line k-line |
| Cover/Optics | Clear (100°)/Clear + Micro louvre/Clear + KKLN-01 lens (18°)/Clear + KKLN-01 lens (18°) + Micro louvre/Clear + KKLN-03 lens (23°)/Clear + KKLN-03 lens (23°) + Micro louvre/Clear + KKLN-02 Asymmetric lens (Beam tilt 15°, Beam angle 45°)/Diffused (95°) |
| CCT | s-line: 1900K/2100K/2300K/2500K/2700K/3000K/3500K/4000K/5000K k-line: 1900K/2100K/2300K/2500K/2700K/3000K/3500K/4000K/5000K |
| LED binning | s-line: 2-step MacAdam ellipse k-line: 3-step MacAdam ellipse |
| CRI | ≥ 92 |
| Lifetime | 50,000 hours @ 25°C (50,000 hours @ 77°F) |
| Operating temp | T _a = -25 to 45°C (T _c max = 80.9°C) T _a = -13 to 113°F (T _c max = 178°F) |
| IP Rating | IP44/67 |
| Finish | Silver anodised |
| Mounting | Recessed mounting via spring clip/Cable race way |
| Power feed | Sheathed hardwire tails or male/female connectors |
| Control | 0-10V/1-10V/DMX/DALI |



LED Grading Key

Exclusive Grade

| | |
|------------------|-----------------------|
| s s-line* | *KKDC tuned CCT range |
| 2-step CCT range | |

Base Grade

| | |
|-----------------|---|
| k k-line | 3-step commercial range Energy Star CCTs |
|-----------------|---|

| | | |
|--------------------------|-----------------------|-----------------------|
| Power consumption | Supply voltage | Supply current |
| 30W/m (9.14W/ft) | 24V DC | 1.25A/m (0.38A/ft) |

Performance Data (3000K)

| | R1 | R2 | R3 | R4 | R5 | R6 | R7 | R8 | R9 | R10 | R11 | R12 | R13 | R14 |
|---------------|------------------------------------|-----------------------------------|------------------------------------|---|------------------------------------|---|--|------------------------------------|------------|-----------|-----------|-----------|-----|-----|
| k-line | 92 | 95 | 97 | 91 | 91 | 93 | 93 | 82 | 60 | 88 | 91 | 73 | 93 | 98 |
| | Clear | Clear + Micro Louvre | Clear + KKLN-01 (18°) | Clear + KKLN-01 (18°) + Micro Louvre | Clear + KKLN-03 (23°) | Clear + KKLN-03 (23°) + Micro Louvre | Clear + KKLN-A2 Asymmetric lens | Diffused Cover | CRI | R9 | Rf | Rg | | |
| s-line | 2309lm/m (704lm/ft) 77lm/W | 687lm/m (209lm/ft) 22.9lm/w | 1285lm/m (392lm/ft) 42.8lm/W | 572lm/m (174lm/ft) 19.1lm/W | 1332lm/m (406lm/ft) 44.4lm/W | 760lm/m (232lm/ft) 25.3lm/W | 2306lm/m (703lm/ft) 76.9lm/W | 1040lm/m (317lm/ft) 34.7lm/W | 93 | 61 | - | - | | |
| k-line | 2178lm/m (664lm/ft) 72.6lm/W | 648lm/m (198lm/ft) 21.6lm/w | 1212lm/m (369lm/ft) 40.4lm/W | 540lm/m (165lm/ft) 18lm/W | 1257lm/m (383lm/ft) 41.9lm/W | 717lm/m (219lm/ft) 23.9lm/W | 2175lm/m (663lm/ft) 72.5lm/W | 981lm/m (299lm/ft) 32.7lm/W | 92 | 60 | - | - | | |

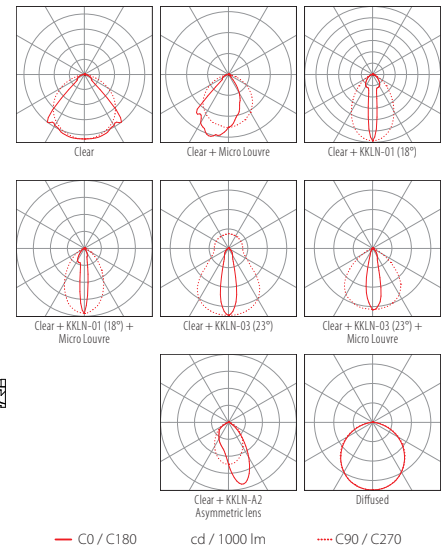
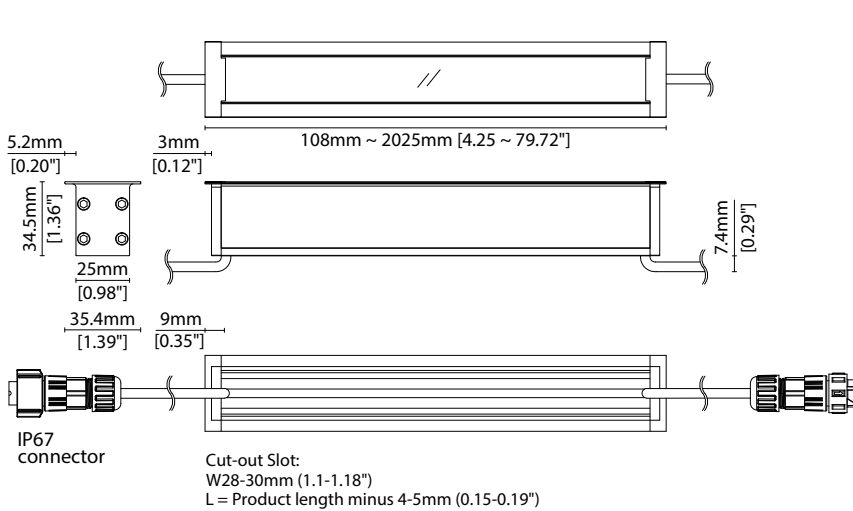

Data derived from production samples tested to UKAS/IESNA LM-79-08 standards.

MOMO-R R030

Code Table



FIXTURE

| Model | Finish | Cover/Lens ¹ | Grade ² | LED | Colour (CCT) | Length Availability ³ | IP | Cable Length | Power Feed ⁴ | Input | | | | | | | | | | | |
|--------|-----------------------|-------------------------|--------------------|-----|--------------|----------------------------------|-------|--------------|-------------------------|-----------------------------------|-------------------|----|------------------|------|------------------------------|------------------------------|-----------|---|--|--|--|
| MOMO-R | OR Silver Anodised | SA Clear | B | s | R030 | R030 | 1900K | 19 | m | 108-2025mm 41.7mm increments | IP44 | 44 | 300mm/ 11.81" | 0300 | Single ø4.3mm sheath tail | S00A | DC 24V | g | | | |
| | | | K | k | | | 2100K | 21 | | | IP67 ⁵ | 67 | | | Double ø4.3mm sheath tail | D00A | | | | | |
| | | | P | | | | 2300K | 23 | i | 4.26-79.72in 1.64in increments | | | | | | Double ø4.3mm sheath tail | | | | | |
| | | | | | | | 2500K | 25 | | | | | | | | | | | | | |
| | | | | | | | 2700K | 27 | | | | | | | | | | | | | |
| | | | | | | | 3000K | 30 | | | | | | | | | | | | | |
| | | | | | | | 3500K | 35 | | | | | | | | | | | | | |
| | | | | | | | 4000K | 40 | | | | | | | | | | | | | |
| | | | | | | | 5000K | 50 | | | | | | | | | | | | | |
| | | | | | | | | | | | | | | | | | | | | | |

¹ Refer to **Cover/Lens Options** on **Options** pages ² Refer to **LED Grading Key** on **Specification sheet** page ³ Refer to **Length Availability List** or enter total run length instead of length code

⁴ Refer to **Power Feed Options** on **Options** pages ⁵ Due to the clear, flush potted polyurethane top layer on IP67 MOMO-R a colour shift of +/- 20K should be expected

Code Example:

| | | | | | | | | | | | | | | | | | | | | | | |
|--------|---|-----------------|---|----------|---|---|---|------|---|-------|---|-------|---|------|---|--------------|---|-------------------------------------|---|--------|---|---|
| OR | - | SA | - | C | - | s | - | R030 | - | 35 | - | m | - | 525 | - | 67 | - | 0300 | - | D67A | - | g |
| MOMO-R | | Silver Anodised | | Diffused | | s | | R030 | | 3500K | | 525mm | | IP67 | | 300mm/11.81" | | Double ø4.3mm sheath IP67 connector | | DC 24V | | |

ACCESSORIES

Mounting Accessories

| | |
|--------------|------------------------------|
| KKSB-01 | Spring bracket |
| KKCR-01-1000 | 1000mm/39.37" Cable Raceway |
| KKCR-01-2000 | 2000mm/78.74" Cable Raceway |
| KKCR-01-3000 | 3000mm/118.11" Cable Raceway |

* Refer to **Mounting accessories** on **Accessories** pages

Connection Accessories

| | |
|--------------|--|
| CN67-2P-0300 | IP67 2 PIN male & female 300mm/11.81" pair |
| CN67-2P-1000 | IP67 2 PIN male & female 1000mm/39.37" pair |
| CN67-2P-3000 | IP67 2 PIN male & female 3000mm/118.11" pair |

* Refer to **Power feed** on **Accessories** pages

Exterior Junction Boxes

| | |
|----------|-----------------------------------|
| KKJB-07 | IP67 Slim J-Box |
| KKJB-07R | Potting Resin for IP67 Slim J-Box |

* Refer to **Exterior Junction Boxes** on **Accessories** pages

PSU/Driver

0-10V/1-10V/DALI/DMX

* Refer to **Driver/PSU Options** page for details or provide requirement and KKDC to offer the suitable option

LED ENGINE VARIANTS (LED STRIP TYPE)

| Colour | LED | Lumen/m | Lumen/ft | W/m | W/ft | Spec Doc | Length | Increment |
|------------------------|-------------|--|--|-----------|-------------|--------------------|----------------------------------|------------------------|
| Single CCT | R007 | 563 | 172 | 7 | 2.13 | MOMO-R R007 | 108-2025mm (4.25-79.72in) | 41.7mm (1.64in) |
| | R014 | 1152 | 351 | 14 | 4.27 | MOMO-R R014 | 108-2025mm (4.25-79.72in) | 41.7mm (1.64in) |
| | R020 | 1632 | 498 | 20 | 6.10 | MOMO-R R020 | 108-2025mm (4.25-79.72in) | 41.7mm (1.64in) |
| | R030 | 2309 | 704 | 30 | 9.14 | MOMO-R R030 | 108-2025mm (4.25-79.72in) | 41.7mm (1.64in) |
| Warm Dim/Dynamic White | A040 | 3668 | 1118 | 40 | 12.19 | MOMO-R A040 | 102-1525mm (4.01-60.03in) | 38.46mm (1.51in) |
| | R207 | 1282 | 391 | 16 | 4.88 | MOMO-R R207 | 108-2025mm (4.25-79.72in) | 83.3mm (3.28in) |
| RGB | 501 | Red 125 Green 266 Blue 42 RGB 383 | Red 38 Green 81 Blue 13 RGB 117 | 15.6 | 4.75 | MOMO-R RGB | 108-2025mm (4.25-79.72in) | 83.3mm (3.28in) |
| RGBW | R201 | 973 | 297 | 20 | 6.1 | MOMO-R RGBW | 160-2035mm (6.30-80.12in) | 62.5mm (2.46in) |

* Performance data: A/s-line, clear cover, 3000K

Linear

MOMO-R R030

Length Availability List



| Length Code | | Fixture Length ¹ | | LED Strip ² | | End Cap Dimension ³ | | Wattage (W) | Output (lm) |
|-------------|--------------|-----------------------------|--------------|------------------------|--------------|--------------------------------|--------------|-------------|----------------------|
| Metric | Imperial(US) | Metric | Imperial(US) | Metric | Imperial(US) | Metric | Imperial(US) | | 3000K (Test Data) |
| m0108 | i0004 | 108mm | 4.27in | 83mm | 3.28in | 15mm | 0.59in | 2.50 | 182 |
| m0150 | i0006 | 150mm | 5.91in | 125mm | 4.92in | 15mm | 0.59in | 3.75 | 272 |
| m0192 | i0008 | 192mm | 7.55in | 167mm | 6.56in | 15mm | 0.59in | 5.00 | 363 |
| m0233 | i0009 | 233mm | 9.19in | 208mm | 8.20in | 15mm | 0.59in | 6.25 | 454 |
| m0275 | i0011 | 275mm | 10.83in | 250mm | 9.84in | 15mm | 0.59in | 7.50 | 544 |
| m0317 | i0012 | 317mm | 12.47in | 292mm | 11.48in | 15mm | 0.59in | 8.75 | 635 |
| m0358 | i0014 | 358mm | 14.11in | 333mm | 13.12in | 15mm | 0.59in | 10.00 | 726 |
| m0400 | i0016 | 400mm | 15.75in | 375mm | 14.76in | 15mm | 0.59in | 11.25 | 817 |
| m0442 | i0017 | 442mm | 17.39in | 417mm | 16.40in | 15mm | 0.59in | 12.50 | 907 |
| m0483 | i0019 | 483mm | 19.03in | 458mm | 18.04in | 15mm | 0.59in | 13.75 | 998 |
| m0525 | i0021 | 525mm | 20.67in | 500mm | 19.69in | 15mm | 0.59in | 15.00 | 1089 |
| m0567 | i0022 | 567mm | 22.31in | 542mm | 21.33in | 15mm | 0.59in | 16.25 | 1180 |
| m0608 | i0024 | 608mm | 23.95in | 583mm | 22.97in | 15mm | 0.59in | 17.50 | 1270 |
| m0650 | i0026 | 650mm | 25.59in | 625mm | 24.61in | 15mm | 0.59in | 18.75 | 1361 |
| m0692 | i0027 | 692mm | 27.23in | 667mm | 26.25in | 15mm | 0.59in | 20.00 | 1452 |
| m0733 | i0029 | 733mm | 28.87in | 708mm | 27.89in | 15mm | 0.59in | 21.25 | 1543 |
| m0775 | i0031 | 775mm | 30.51in | 750mm | 29.53in | 15mm | 0.59in | 22.50 | 1633 |
| m0817 | i0032 | 817mm | 32.15in | 792mm | 31.17in | 15mm | 0.59in | 23.75 | 1724 |
| m0858 | i0034 | 858mm | 33.79in | 833mm | 32.81in | 15mm | 0.59in | 25.00 | 1815 |
| m0900 | i0035 | 900mm | 35.43in | 875mm | 34.45in | 15mm | 0.59in | 26.25 | 1906 |
| m0942 | i0037 | 942mm | 37.07in | 917mm | 36.09in | 15mm | 0.59in | 27.50 | 1996 |
| m0983 | i0039 | 983mm | 38.71in | 958mm | 37.73in | 15mm | 0.59in | 28.75 | 2087 |
| m1025 | i0040 | 1025mm | 40.35in | 1000mm | 39.37in | 15mm | 0.59in | 30.00 | 2178 |
| m1067 | i0042 | 1067mm | 41.99in | 1042mm | 41.01in | 15mm | 0.59in | 31.25 | 2269 |
| m1108 | i0044 | 1108mm | 43.64in | 1083mm | 42.65in | 15mm | 0.59in | 32.50 | 2359 |
| m1150 | i0045 | 1150mm | 45.28in | 1125mm | 44.29in | 15mm | 0.59in | 33.75 | 2450 |
| m1192 | i0047 | 1192mm | 46.92in | 1167mm | 45.93in | 15mm | 0.59in | 35.00 | 2541 |
| m1233 | i0049 | 1233mm | 48.56in | 1208mm | 47.57in | 15mm | 0.59in | 36.25 | 2632 |
| m1275 | i0050 | 1275mm | 50.20in | 1250mm | 49.21in | 15mm | 0.59in | 37.50 | 2722 |
| m1317 | i0052 | 1317mm | 51.84in | 1292mm | 50.85in | 15mm | 0.59in | 38.75 | 2813 |
| m1358 | i0053 | 1358mm | 53.48in | 1333mm | 52.49in | 15mm | 0.59in | 40.00 | 2904 |
| m1400 | i0055 | 1400mm | 55.12in | 1375mm | 54.13in | 15mm | 0.59in | 41.25 | 2995 |
| m1442 | i0057 | 1442mm | 56.76in | 1417mm | 55.77in | 15mm | 0.59in | 42.50 | 3085 |
| m1483 | i0058 | 1483mm | 58.40in | 1458mm | 57.41in | 15mm | 0.59in | 43.75 | 3176 |
| m1525 | i0060 | 1525mm | 60.04in | 1500mm | 59.06in | 15mm | 0.59in | 45.00 | 3267 |
| m1567 | i0062 | 1567mm | 61.68in | 1542mm | 60.70in | 15mm | 0.59in | 46.25 | 3358 |
| m1608 | i0063 | 1608mm | 63.32in | 1583mm | 62.34in | 15mm | 0.59in | 47.50 | 3448 |
| m1650 | i0065 | 1650mm | 64.96in | 1625mm | 63.98in | 15mm | 0.59in | 48.75 | 3539 |
| m1692 | i0067 | 1692mm | 66.60in | 1667mm | 65.62in | 15mm | 0.59in | 50.00 | 3630 |
| m1733 | i0068 | 1733mm | 68.24in | 1708mm | 67.26in | 15mm | 0.59in | 51.25 | 3721 |
| m1775 | i0070 | 1775mm | 69.88in | 1750mm | 68.90in | 15mm | 0.59in | 52.50 | 3811 |
| m1817 | i0072 | 1817mm | 71.52in | 1792mm | 70.54in | 15mm | 0.59in | 53.75 | 3902 |
| m1858 | i0073 | 1858mm | 73.16in | 1833mm | 72.18in | 15mm | 0.59in | 55.00 | 3993 |

MOMO-R R030

Length Availability List



| Length Code | | Fixture Length ¹ | | LED Strip ² | | End Cap Dimension ³ | | Wattage (W) | Output (lm) |
|-------------|--------------|-----------------------------|--------------|------------------------|--------------|--------------------------------|--------------|-------------|----------------------|
| Metric | Imperial(US) | Metric | Imperial(US) | Metric | Imperial(US) | Metric | Imperial(US) | | 3000K (Test Data) |
| m1900 | i0075 | 1900mm | 74.80in | 1875mm | 73.82in | 15mm | 0.59in | 56.25 | 4084 |
| m1942 | i0076 | 1942mm | 76.44in | 1917mm | 75.46in | 15mm | 0.59in | 57.50 | 4174 |
| m1983 | i0078 | 1983mm | 78.08in | 1958mm | 77.10in | 15mm | 0.59in | 58.75 | 4265 |
| m2025 | i0080 | 2025mm | 79.72in | 2000mm | 78.74in | 15mm | 0.59in | 60.00 | 4356 |

¹ Actual total overall length of light fixture (LED strip + end caps + void/wire hole)

² Actual length of PCB strip

³ Actual length of 2x end caps

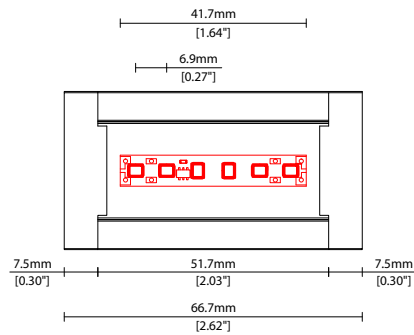

CUT-OUT SLOT:

W28-30mm (1.1-1.18")

L = Product length minus 4-5mm (0.15-0.19")

COVER/LENS OPTIONS

* Options are an integral part of the fixture ordering codes. Please refer to **Code Table** pages.

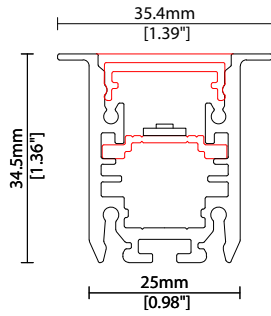
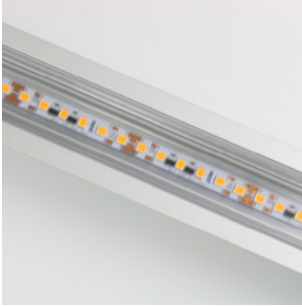

B Clear Cover
W25.0/H34.5mm (W0.98/H1.36")

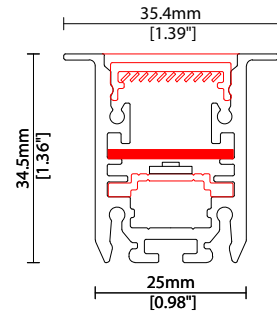

K Clear Cover + Micro Louvre
W25.0/H34.5mm (W0.98/H1.36")

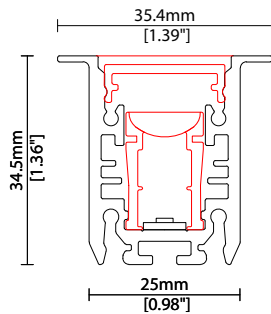
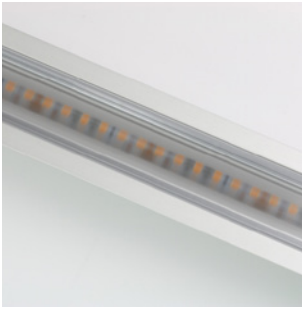

P Clear + KKLN-01 (18°)
W25.0/H34.5mm (W0.98/H1.36")

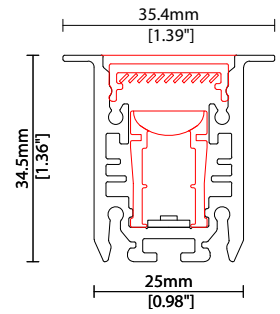
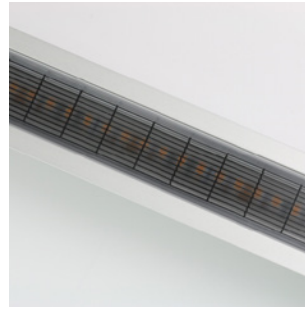

U Clear + KKLN-01 (18°)
+ Micro Louvre
W25.0/H34.5mm (W0.98/H1.36")

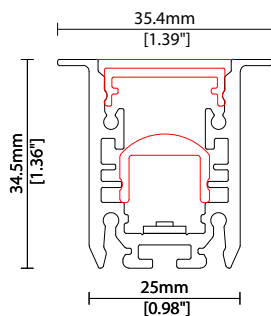

A Clear + KKLN-03 (23°)
W25.0/H34.5mm (W0.98/H1.36")

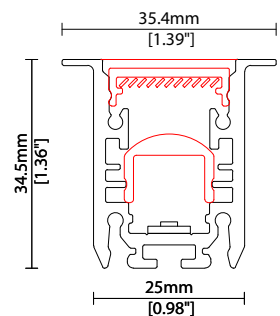

AK Clear + KKLN-03 (23°)
+ Micro Louvre
W25.0/H34.5mm (W0.98/H1.36")

Linear

MOMO-R R030

Options

KKDC



BA2 Clear + KKLN-A2

W25.0/H34.5mm (W0.98/H1.36")

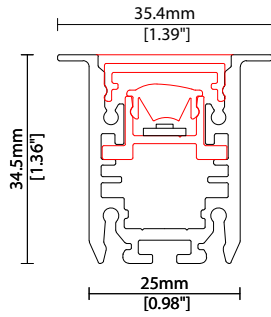

C Diffused

W25.0/H34.5mm (W0.98/H1.36")

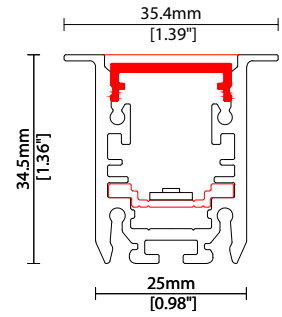

POWER FEED OPTIONS

0300 S00A 300mm (11.81") Single Ø4.3mm sheath tail

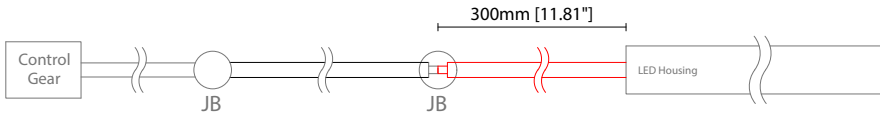

0300 D00A 300mm (11.81") Double Ø4.3mm sheath tail

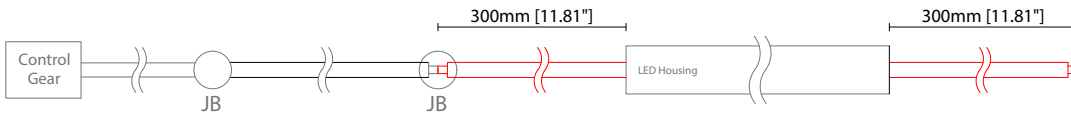

0300 S67A 300mm (11.81") Single ø4.3mm sheath IP67 connector

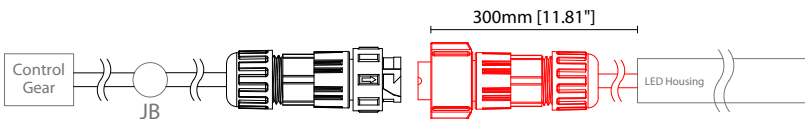

0300 D67A 300mm (11.81") Double ø4.3mm sheath IP67 connector

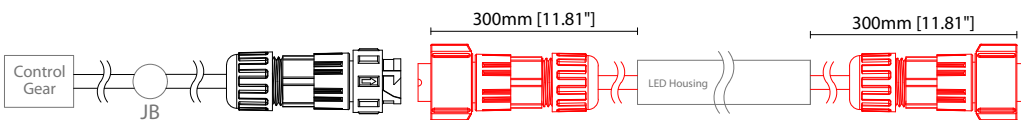

IP67 2 Pin Connector

Female connector
2 PIN (IP67)

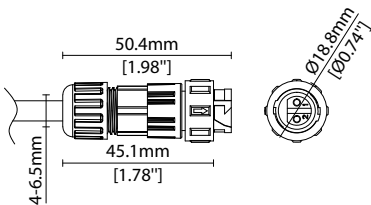

Male connector
2 PIN (IP67)

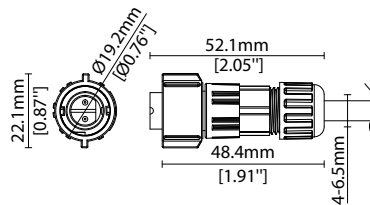

Key

- Control Gear Power supply, sub-controllers & control systems
- JB Junction box / cable connection

MOUNTING ACCESSORIES

Note: Accessories are to be ordered separately with corresponding code shown below.

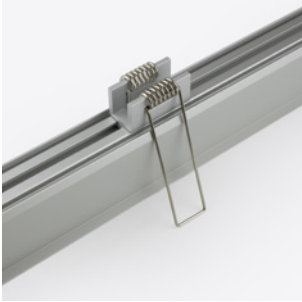

KKS-01

Spring bracket
(allow 2 per metre/40")
Anodised aluminium finish
L31/W35.4/H45.2mm
(L1.22/W1.39/H1.78")

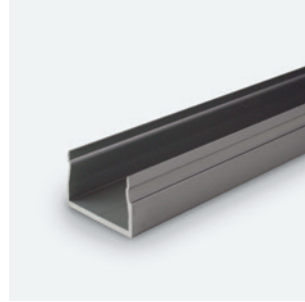
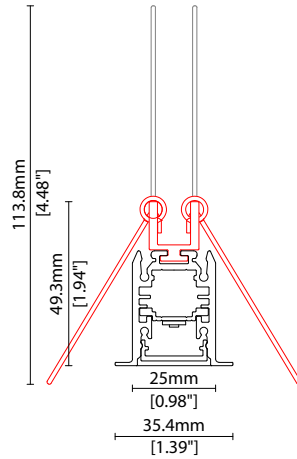

| | |
|--------------|-------------------|
| KKCR-01-1000 | 1000mm (39.37in) |
| KKCR-01-2000 | 2000mm (78.74in) |
| KKCR-01-3000 | 3000mm (118.11in) |

Cable raceway*
anodised aluminium finish
W22/H36.4mm (W0.87/H1.43")

* Cut & drilled to fit on site

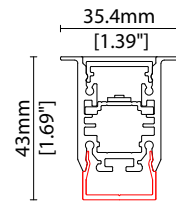

POWER FEED

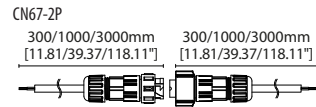

| | |
|--------------|------------------------|
| CN67-2P-0300 | 300mm (11.81in) pair |
| CN67-2P-1000 | 1000mm (39.37in) pair |
| CN67-2P-3000 | 3000mm (118.11in) pair |

IP67

2 PIN male + female connector set

Linear

MOMO-R R030 Accessories

KKDC

EXTERIOR JUNCTION BOXES



KKJB-07

IP67 Slim J-Box
(including type A,B,C,D bushings)



KKJB-07R

Potting resin for IP67 Slim J-Box

KKDC CONTROL



KKDM-06 1-10V

visDIM dimmable sub-controller
(4 x 8A max @ 12-36V)

IP20
Plastic housing
L170/W59/H29mm
(L6.69/W2.32/H1.14in)



KKSC-05 DMX

visDIM dimmable sub-controller
(4 x 5A max @ 12-36V)

IP20
Plastic housing
L170/W53.4/H28mm
(L6.69/W2.10/H1.10in)



KKDL-02 DALI

visDIM dimmable sub-controller
(4 x 8A max @ 12-36V)

IP20
Plastic housing
L170/W59/H29mm
(L6.69/W2.32/H1.14in)



KKDL-03 DALI

visDIM dimmable sub-controller
(4 x 5A max @ 12-36V)

IP20
Plastic housing
L166/W53.4/H23mm
(L6.54/W2.10/H0.91in)

AVAILABLE PSU OPTIONS

| Control Mode | PSU (Order Code) | Input Voltage AC | Output Voltage DC | Rated Output Current | Rated Power | Dim % | IP Rating |
|---------------|------------------|------------------|-------------------|----------------------|-------------|-------------------|-----------|
| Switched | CEN-60-24 | 90-295V | 24V | 2.5A | 60W | - | IP67 |
| | HLG-60H-24 | 90-305V | 24V | 2.5A | 60W | - | IP67 |
| | HLG-100H-24 | 90-305V | 24V | 4.0A | 100W | - | IP67 |
| | HLG-150H-24 | 90-305V | 24V | 6.3A | 150W | - | IP67 |
| | HLG-240H-24 | 90-305V | 24V | 10A | 240W | - | IP67 |
| 0-10V (1-10V) | PWM-40-24 | 90-305V | 24V | 1.67A | 40W | 100-0.15 (100-10) | IP67 |
| | PWM-60-24 | 90-305V | 24V | 2.5A | 60W | 100-0.15 (100-10) | IP67 |
| | PWM-90-24 | 90-305V | 24V | 3.67A | 90W | 100-0.15 (100-10) | IP67 |
| | PWM-120-24 | 90-305V | 24V | 5.0A | 120W | 100-0.15 (100-10) | IP67 |
| DALI | LIN100A1 | 120-277V | 24V | 1A per channel | 100W | 100-0.1 | IP66/IP40 |
| DMX RGB | LIN100A1 | 120-277V | 24V | 1.33A per channel | 100W | 100-0.1 | IP66/IP40 |
| DMX RGBW | LIN100A1 | 120-277A | 24V | 1A per channel | 100W | 100-0.1 | IP66/IP40 |

Flicker Free Options - Combination of PSU+ sub-controller

| Control Mode | PSU (Order Code) | Sub-controller (Order Code) | Input Voltage AC | Output Voltage DC | Rated Output Current | Rated Power | Dim % | IP Rating PSU/ Sub-controller |
|----------------|------------------|-----------------------------|------------------|-------------------|----------------------|-------------|---------|-------------------------------|
| 0-10V or 1-10V | CEN-60-24 | KKDM-06 | 90-295V | 24V | 2.5A | 60W | 100-0.9 | IP67/IP20 |
| | HLG-60H-24 | KKDM-06 | 90-295V | 24V | 2.5A | 60W | 100-0.9 | IP67/IP20 |
| | HLG-100H-24 | KKDM-06 | 90-295V | 24V | 4.0A | 100W | 100-0.9 | IP67/IP20 |
| | HLG-150H-24 | KKDM-06 | 90-295V | 24V | 6.3A | 150W | 100-0.9 | IP67/IP20 |
| | HLG-240H-24 | KKDM-06 | 90-295V | 24V | 10.0A | 240W | 100-0.9 | IP67/IP20 |
| DALI | CEN-60-24 | KKDL-02/03 | 90-295V | 24V | 2.5A | 60W | 100-0.1 | IP67/IP20 |
| | HLG-60H-24 | KKDL-02/03 | 90-305V | 24V | 2.5A | 60W | 100-0.1 | IP67/IP20 |
| | HLG-100H-24 | KKDL-02/03 | 90-305V | 24V | 4.0A | 100W | 100-0.1 | IP67/IP20 |
| | HLG-150H-24 | KKDL-02/03 | 90-305V | 24V | 6.3A | 150W | 100-0.1 | IP67/IP20 |
| | HLG-240H-24 | KKDL-02/03 | 90-305V | 24V | 10.0A | 240W | 100-0.1 | IP67/IP20 |
| DMX RGB | CEN-60-24 | KKSC-05 | 90-295V | 24V | 2.5A | 60W | 100-0.9 | IP67/IP20 |
| | HLG-60H-24 | KKSC-05 | 90-305V | 24V | 2.5A | 60W | 100-0.9 | IP67/IP20 |
| | HLG-100H-24 | KKSC-05 | 90-305V | 24V | 4A | 100W | 100-0.9 | IP67/IP20 |
| | HLG-150H-24 | KKSC-05 | 90-305V | 24V | 6.3A | 150W | 100-0.9 | IP67/IP20 |
| | HLG-240H-24 | KKSC-05 | 90-305V | 24V | 10.0A | 240W | 100-0.9 | IP67/IP20 |

¹ The items shown above cover the most frequently used specification but does not exhaust the possible options

² PSU and/or driver can be chosen from the table, or KKDC may recommend the best option upon receipt of the controls requirement and installation environment

³ Electrical shop drawing will include detailed information of PSU and relevant control drivers

⁴ Cut sheets are available on the controls section of www.kkdc.lighting or upon request